

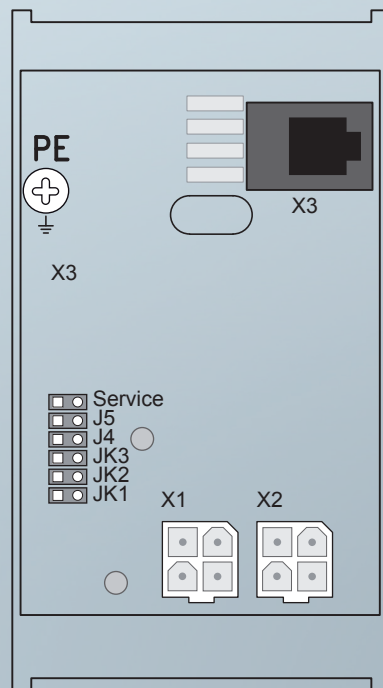

Load Control System



Manufacturer NEW *LIFT* Steuerungsbau GmbH
Lochhamer Schlag 8
82166 Gräfelfing
Tel +49 89 - 898 66 - 0
Fax +49 89 - 898 66 - 300
Mail info@newlift.de
www.newlift.de

Service line Tel +49 89 - 898 66 - 110
Mail service@newlift.de

Date of issue 31.10.2013

Author TB / SWB

Last Change 23.11.2020 AME

Release 23.11.2020 AL

Hardware version 2.0

Software version LCS V 14

Doc. No. hb_lcs_2020-07_en

Copyright © NEW *LIFT* Steuerungsbau GmbH, 2020.

This manual is protected by copyright. All rights, including those of copying, of reproduction, of translation and of modification, in whole or in part, are reserved by the publisher.

No part of this description may be reproduced in any form or copied with an electronic replication system without written permission.

Although great care has been taken in the production of texts and figures, we cannot be held legally liable for possible mistakes and their consequences.

Contents

1	General	4
1.1	Abbreviations, characters and symbols used	4
1.2	Notation	5
1.3	Further information	5
1.4	How to contact us	5
2	Safety	6
2.1	General safety regulations	6
2.2	Standards and regulations applied	6
2.3	Electromagnetic compatibility (EMC)	6
2.4	Handling electronic assemblies	6
3	Technical data	7
3.1	Pin assignment and configuration	7
4	Hardware configuration	8
5	Installation notes for load sensors	8
5.1	Installation options of load sensors on lift	9
5.2	LCS with multi rope sensors (LCS-MR)	10
5.3	LCS with DMS sensors (LCS-DM)	11
6	Calibration of LCS	13
6.1	Calibration guide using the FST keypad	13
6.2	Calibration guide using the car panel	14
6.3	Checking the calibration results	15
6.4	Testing the LCS measurement quality	15
6.5	Compensation Options	17
6.6	Re-calibration after gripping device test	19
7	FST parameter settings	20
8	Error messages and diagnostics	22

1 General



The LCS (Load Control System) is used for the load monitoring of cable lift systems and is available in two different styles:

- with a multi rope sensor (LCS-MR) to measure cable tension (standard)
- with a DMS sensor (LCS-DM) for installation on the car frame and to measure bending stress

The simple connection to the FST 's internal LON bus allows for simple installation of the monitoring device and enables comfortable parametrising and calibration of the LCS during commissioning.

The following manual describes in detail the individual properties of position indicators.

1.1 Abbreviations, characters and symbols used

Symbol / abbreviation	Meaning
LCS	Load Control System
*	Delivery condition Settings that are supplied as standard are marked with an asterisk *
P	Power
I	Input
O	Output
L	Low activ
H	High activ
▶	Operational instructions Perform the tasks that follow this symbol in the specified order.
	Warning notice This symbol is located in front of safety-relevant information
	Information notice This symbol is located in front of relevant information.

1.2 Notation

Notation	Meaning
Bold	› Designations of switches and actuators › Input values
<i>Italics</i>	› Captions › Cross references › Designations of functions and signals › Product names
<i>Bold italics</i>	› Remarks
LCD font	› System messages of the controller

1.3 Further information

The following documents, among others, are available for the FST control system and its components:

- › ADM Manual
- › EAZ 256 Manual
- › EAZ TFT.45.110.210 Manual
- › EN81-20 Manual
- › FPM Manual
- › FST-2XT/s Manual
- › FST-2XT MRL Manual
- › FST Installation & Commissioning Manual
- › GST-XT Manual
- › RIO Manual
- › SAM Manual
- › UCM-A3 Manual
- › Update-Backup-Analysis Manual

These and other up to date manuals can be found in the download area of our website at <https://www.newlift.de/downloads-311.html>

1.4 How to contact us

If, after referring to this manual, you still require assistance, our service line is there for you:

Phone +49 89 – 898 66 – 110
E-mail service@newlift.de
Mon. - Thurs.: 8:00 a.m. – 12:00 p.m. and 1:00 p.m. – 5:00 p.m.
Fr: 8:00 a.m. – 3:00 p.m.

2 Safety

2.1 General safety regulations

The LCS (Load Control System) must be in technically perfect condition and may only be used in accordance with regulations and in awareness of safety and risks. The “FST Installation & Commissioning” manual as well as the relevant guidelines for the prevention of accidents and the guidelines of local power utilities must be observed.



Basically, the safety regulations of the FST manual and the FST manual installation & commissioning apply.

2.2 Standards and regulations applied

The LCS (Load Control System) complies with:

- › safety regulations for the construction and installation of passenger and goods lifts (DIN EN 81 Parts 1 and 2)
- › regulations for the erection of power installations with rated voltages of up to 1kV (DIN VDE 0100)
- › measures to prevent accidental contacts in the machine room (VDE 0106).
- › data sheet on safety measures during installation, maintenance and servicing or repair of lift systems (ZH 1/312).

2.3 Electromagnetic compatibility (EMC)

An accredited inspection body has verified that the FST controller and its components comply with the standards, limits and test intensities according to EN12015/1995 and EN12016/1995.

The FST controller and its components are:

- › resistant against electrostatic discharges (EN 61000-4-2/1995)
- › resistant against electrostatic fields (EN 61000-4-3/1997)
- › resistant against transient disturbances (EN 61000-4-4/1995)

The field strengths of the electromagnetic disturbances radiated by the FST controller and its components do not exceed the permitted limits (EN 55011/1997).

2.4 Handling electronic assemblies



- › Leave electronic assemblies in their original packaging until installation.
- › Touch a grounded piece of metal prior to opening the original packaging to prevent damage from static charges.
- › During work on electronic assemblies, periodically perform this discharge procedure.
- › All bus inputs or outputs not in use must be equipped with a terminal resistor (terminator).

3 Technical data

Description	Value
Supply voltage	24 V DC ±10%
Typical current consumption	300 mA
Outputs	short circuit proof
Length x Height x Depth	90 x 50 x 48 mm
Installation	DIN TS 35 mounting rail
Temperature range: Storage & Transportation / Operation	-20 - +70 °C / ±0 - +60 °C
Relative humidity: Storage & Transportation / Operation (non-condensing).	+5 - +95 % / +15 - +85 %

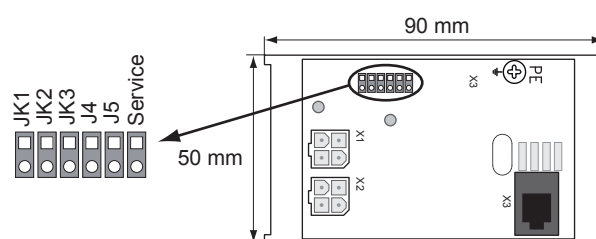

3.1 Pin assignment and configuration

X1, X2: Bus connections

LCS X1, X2	Colour code	Signal / Function
1	black	RS-485 LON-Bus „A“
2	white	RS-485 LON-Bus „B“
3	red	Supply +24V
4	magenta	Supply GND or 0V

X3: Sensor connection X3

LCS X3	Colour code sensor	Signal / Function
1	red	VREF+
2	black	VREF-
3	green	SIGNAL+
4	white	SIGNAL-



The LCS must be installed on a grounded supply bus to make sure there is a connection to the protective conductor (PE)! If this is not possible, the PE connector of the LCS must be connected directly to the protective earth conductor! Make sure that the connection is as short and direct as possible!

4 Hardware configuration

The jumper settings for FST group assignment

FST-ID	Jumper JK1	Jumper JK2	Jumper JK3
FST-A *	open	open	open
FST-B	closed	open	open
FST-C	open	closed	open
FST-D	closed	closed	open
FST-E	open	open	closed
FST-F	closed	open	closed
FST-G	open	closed	closed
FST-H	closed	closed	closed

Jumper J4 and J5 are exclusively used by New *Lift* and must not be plugged in.

5 Installation notes for load sensors

Please observe the following installation instructions carefully to ensure optimum measuring results and the required accuracy.

The following mechanical basic requirements of the lift must be followed to guarantee the proper function of the LCS. The sensors for installation of crossbars and cables are based on the principle of bending as well as pulling.

If the sensor can be bent (micrometer range), an analogue signal will be transmitted from the resistance bridge circuit (wheatstone measurement bridge) to the LCS-module.

If there is no bending or bending is not enough, no or low signal transmission takes place. This results in an faulty or useless measurement.

For compensation of the overdriven signal transmission the LCS provides the following options:

- › „Freezing“ function of the measured load: This will be carried out before the drive starts (if the door is closed) and ends after the relevant drive.
- › Measurement of the deviation of the calibrated empty load in each floor. Hence the value of the calibrated empty load will be calculated individually.
- › Therefore, the calibrated empty load is calculated individually (in comparison with the deviation of each floor about 0 kg).
- › Rounding of weight fluctuations after each drive $\leq 30\text{Kg}$ to 0Kg.
- › After 2 hours the measured weight will be set to „0“. This doesn't depend on the load in the car. Attention! This function can affect the operational safety of the lift system, it is always deactivated when the product leaves the factory!

5.1 Installation options of load sensors on lift

The following installation options are available for the load sensors:

- › DMS-Sensor on car frame ①
- › Multi rope sensor on car after rope clamps ②
- › DMS sensor on fixed point of rope attachment ③
- › Multi rope sensor on fixed point of rope attachment after rope clamps ④
- › DMS sensor on drive frame ⑤

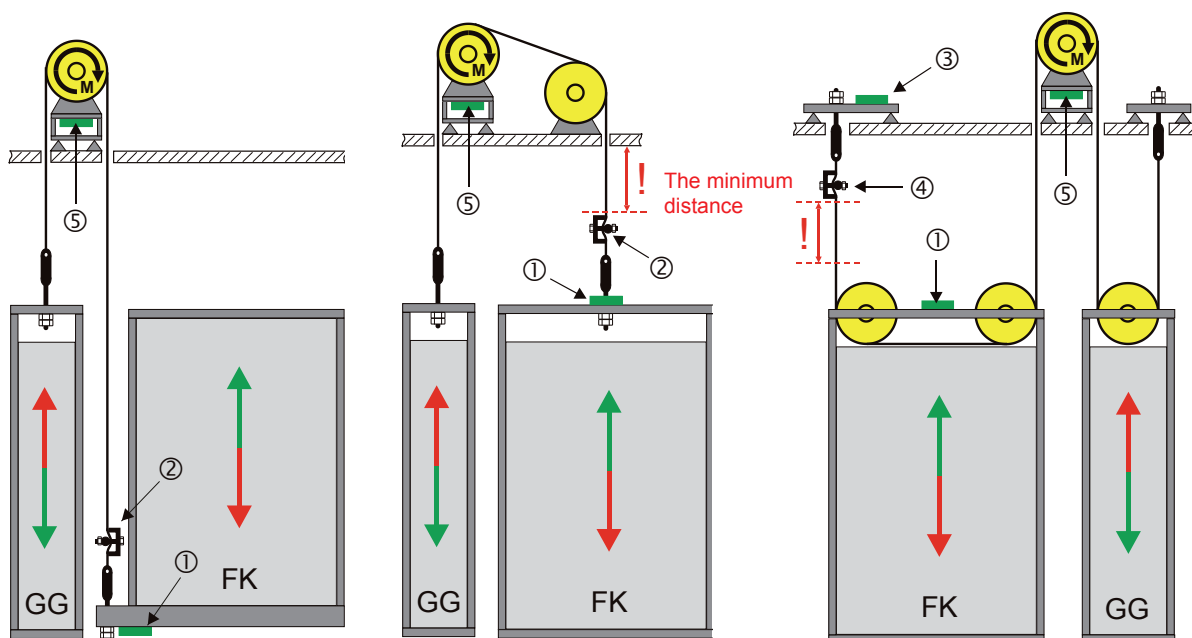

Attachment 1:1 rucksack

Normal attachment 1:1

Attachment 2:1

If the load sensor is travelling with the car, the LCS monitoring device is also installed on the car (in the service box or the backplane of the car panel).

If the load sensor is installed stationary at a fixed point on the rope attachment or the drive frame, the LCS monitoring device is installed in the control cabinet or in a separate box in close proximity of the sensor.

The length of the load sensor connection cable is around 5 m. The sensor cable should not be extended as this could lead to false load measuring results.

5.2 LCS with multi rope sensors (LCS-MR)

Multi rope sensors are integrated in the support ropes and measure the load dependant rope tension. With 1:1 attachments, the load sensor is installed on the car after the rope clamps and integrated into the rope so it travels with the car and the LCS monitoring device is located in the service box or the backplane of the car panel.

With n:1-attachments (n=2,4,...) the load sensor is installed stationary at a fixed point in the support ropes and the monitoring device is located in the control cabinet or in a separate box.

The multi rope sensor consists of the following components:

- › 1 unit multirope sensor for ropes MR; 200 mm [A]
 - › 1 unit deformation bar [B]
 - › 2 bolts, type TE M8 class 8.8 DIN 933 (calibrated length depends on rope diameter) [C]
- Length:
- »A: from 6 mm to 8 mm rope diameter
 - »B: from 9 mm to 11 mm rope diameter
 - »C: from 12 mm to 14 mm rope diameter
 - »D: from 15 mm to 16 mm rope diameter



LCS-MR should only be used with the bolts supplied by NEW LIFT. In any case, please check if bolts are suitable for local rope diameter.

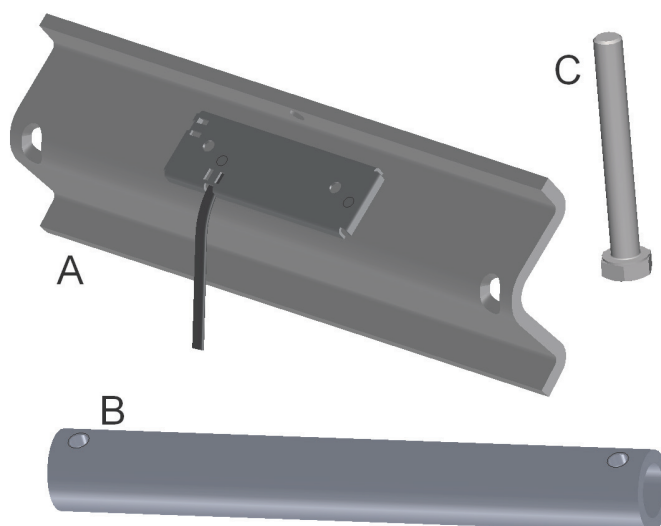

Installation

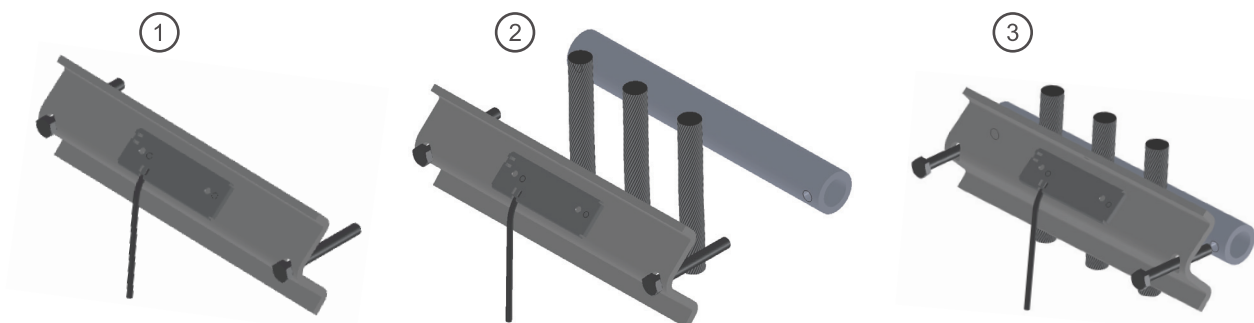

- › Install the screws on the sensor as specified in the picture. ①
- › Position the sensor so that the ropes are located between two screws. Pay attention to parallel alignment of the rope suspension. The ropes must not overlap. ②
- › Fasten the deformation bar by using 2 screws on multi rope sensor. Be sure that the ropes are distributed evenly to guarantee an accurate measuring. ③
- › Tighten the screws until stop position is reached so that the screws touch the inside of the deformation bar. That's the only way you can get the **correct** rope deflections and an exact measuring result.
- › Using the supplied cable, connect the sensor to the LON bus of the FST controller. For this purpose connect the cable to the LCS in the car top box or in the control cabinet.
- › After professional installation of the sensor, carry out some drives with the maximum load.



The support cables must only touch the load sensor at the deformation bar and the rounded edges of the channel section! The load sensor must not move and must be fastened to the support cables.

5.3 LCS with DMS sensors (LCS-DM)

DMS sensors are mounted to load bearing members of the car or shaft assembly that are stressed with bending loads during operation.

The bending is recorded by the DMS sensor and sent to the LCS for evaluation.

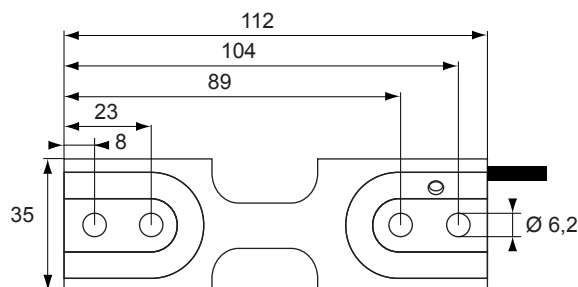
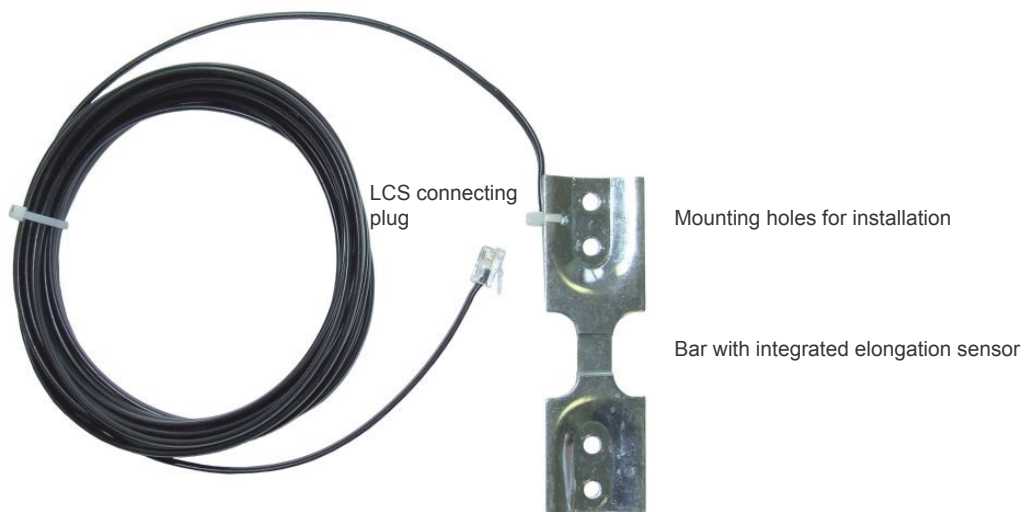

With 1:1 attachments, the DMS sensor is installed on the car cross member that holds the support cables so that it travels with the car and the LCS monitoring device is located in the service box or the backplane of the car panel.

With n:1- attachments (n=2,4,...) the DMS sensor is installed stationary at affixed point where the support cables are mounted and the LCS device is located in the control cabinet or in a separate box.

Installation

- › The sensor must not be stressed mechanically before installation
- › Install the sensor flat and without tension on the load bearing member
- › Install the sensor using 4 bolts and securing nuts
- › Use only the supplied bolts or bolts M6 type 8.8 and suitable nuts! Do not use spring or lock washers, only use flat washers!
- › Tighten the screws with a maximum torque of 10Nm.
- › The surface for mounting the load sensor must meet the following requirements:
 - » No welds in the sensor area
 - » Plane surface free of grease and paint without distortions or unevenness

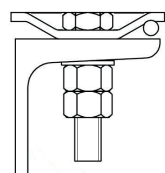
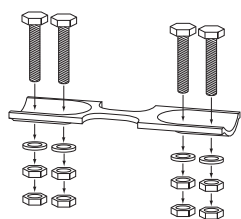

Installation on C-profile

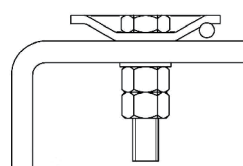

Installation on bent sheet

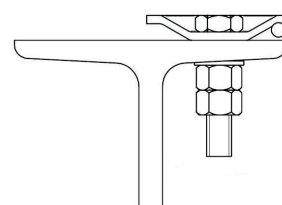

Installation on T-profil



The mounting area of the DMS sensor must be free from paint and paint residue. This means that all paint must be removed from this area before installation!

Trespassing, tool storage, load on the sensor or similar can lead to damage or re-calibration of LCS system with a reference load! To avoid these influences select a suitable place!

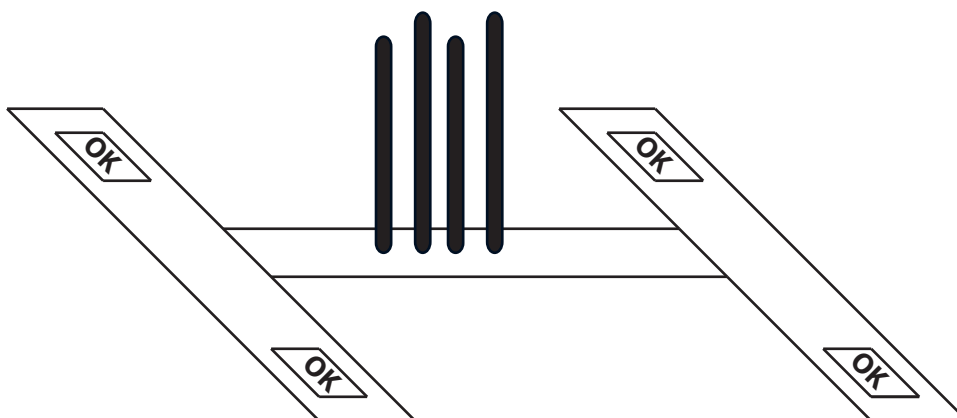

6 Calibration of LCS

Thanks to the linear operation of the load sensor, the LCS calibration can be performed with a reference load significantly below the actual permitted load of the lift system.

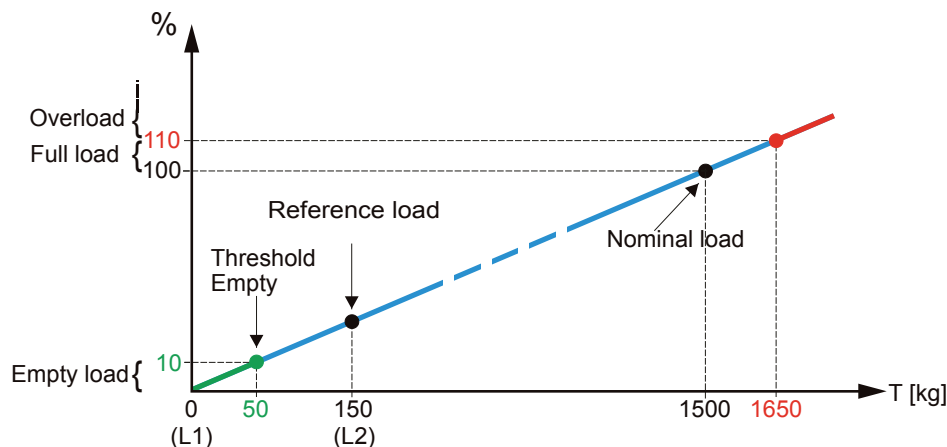

To calculate the characteristic curve for load measurements, the LCS must perform two measurements:

- › Measure the empty car
- › Measure the car with reference load

Using these two values and the nominal load of the lift system the LCS can determine the load of the car in kg. The empty car limit can be changed using a parameter, the overload limit is set automatically at 110%.



Note that the best results can be achieved with larger values of reference load

6.1 Calibration guide using the FST keypad

Basic settings LCS:

```
> SelectMain menu / Config / Weight Sensor / Sensor Type / LCS
load-Control-sys
```

Press the left arrow key until the message `save changed settings` is displayed, confirm with YES

```
> go back to Weight Sensor / LCS Settings / > Threshold - Empty 0000 >
Threshold Full -> set lift max. capacity
```

> set lift max. capacity.

Press the left arrow key until the message `save changed settings` is displayed, confirm with YES

Complete lift system installation and optimise drive characteristics.

► Measure the empty car:

» Press **Shift** + **▶** until in the line C (L= xxxx) is displayed, to be able to control the weight on the display

» `Config / Weight Sensor / LCS Settings / Cal.-Empty (L1) = YES`

» Wait until `LCS [L1] calibrated!` flashes in line B of the FST display.

► Enter reference load in the menu item `Config / Weight Sensor / LCS Settings / Ref. weight (L2)`

► Place reference load in the car and measure reference load

» `Config / Weight Sensor / LCS Settings / Cal.-Ref. weight (L2) = YES`

» Wait until `LCS [L2] calibrated!` flashes in line B of the FST display.

The LCS is now completely calibrated and ready for use. To verify operation of the load measuring system, the current load can be displayed in the line C of the FST display.

Press **Shift**+**▶** or **Shift**+**◀** until **L= xxxxx kg** is displayed. If you enter the car or otherwise put a load on the car, this value changes and displays the current load in kg.

6.2 Calibration guide using the car panel

The LCS can be calibrated using the car panel when EAZ-256, EAZ-VFD and EAZ-LCD are used as position indicators in the car.

Complete lift system installation and optimise drive characteristics.

- ▶ Install load sensor according to respective installation instructions (see chapter „5 Installation notes for load sensors“, on page 8)
- ▶ Complete at least 10 drivers at nominal speed over the entire lifting height
- ▶ Enter reference load in the menu item `Config / Weight Sensor / LCS Settings / Ref. weight (L2)`
- ▶ Activate car panel calibration on the FST:
`Config / Weight Sensor / LCS Settings / Cal.(L1/L2) from COP = YES`
- ✓ Landing control is turned off, the car doors open and the FST display reads `Calib. [L1/L2]-COP` in line B
- ▶ Move car to the lowest floor with an in-car call
- ▶ Press door open button and hold for three seconds: position indicator displays – –
- ▶ Press and hold in-car call for lowest floor until **L1** is displayed to measure the empty car
- ▶ Press door open button again and hold it for three seconds: eight seconds delay to leave the car are started (8 7 6 5 4 3 2 1); at the end of the countdown, the measurement is performed and confirmed
- ✓ After completion of a successful measuring, the message **OK** appears in the indicator or the message `LCS [L1] calibrated!` appears on the FST display.
- ▶ Load car with reference load
- ▶ Press door open button and hold it for three seconds: position indicator displays – –
- ▶ Press and hold in-car call for lowest floor until **L2** is displayed to measure the reference load.
- ▶ Press door open button again and hold it for three seconds: eight seconds delay to leave the car are started (8 7 6 5 4 3 2 1); at the end of the countdown the measurement is performed.
- ✓ After completion of a successful measuring, the message **OK** appears in the indicator or the message `LCS [L2] calibrated!` appears on the FST display.
- ▶ Deactivate car panel calibration on the FST:
`Config / Weight Sensor / LCS Settings / Calib.(L1/L2) from COP = NO`
- ✓ Landing control is activated and the car doors close again

The LCS is now completely calibrated and ready for use. To verify operation of the load measuring system, the current load can be displayed in the line C of the FST display. Press **Shift**+**▶** or **Shift**+**◀** until **L= 0 kg** is displayed. If you enter the car or otherwise put a load on the car, this value changes and displays the current load in kg.

6.3 Checking the calibration results

After calibrating the LCS, check that the minimum required difference between the Empty and Reference load measurements has been met.

Using **Shift**+**▶** or **Shift**+**◀**, the Line-C display will show the current weight as „L=xxxx kg“. If this is the case, the minimum signal requirements have been achieved. If „L=ERR2“ is shown, the signal level difference between the two measurements is too small. This means the LCS is not bending enough with the reference load being used.

The raw unscaled ADC input measurement of the LCS can be displayed with **Service**

Line3: Info-Display and pressing **Shift**+**▶** repeatedly until „LCS xxxx Ex Fx 0x“ is shown. The number „xxxx“ represents the voltage measured across the LCS sensor strain gauge bridge and will change as the sensor bends. The absolute value of this number itself is unimportant, but by checking the range of the number between the Empty and Reference loading conditions, the suitability of the sensor signal can be evaluated. The minimum range of this number must be >200 to satisfy the calibration and prevent the ERR 2 failure from occurring.

Note: a value of 200 represents the absolute minimum signal difference and is so small that the LCS is unlikely to produce reliable weight measurements. A „usable“ value would be at least 1000 or more.

Activate **Shift**+**▶**+**◀**:Info-Display once more to return to the standard Line-C display.

After Calibration, Line-C shows „L=ERR2“

The difference in signal level between the Empty and Reference load conditions is too small. Correctly mounted, the LCS strain gauge sensors measure extremely small displacements in the range of micrometers. The result ERR-2 indicates that the measured deflection of the sensor is too small and that the current mounting location is possibly unsuitable. Specifically:

Remediation measure:

DMS-Sensor: The underlying metal construction is not bending enough. This is sometimes the case in low-capacity lift cars which have been constructed too rigidly. Another mounting place for the sensor must be chosen, or even a change to the car construction considered.

Multirope-Sensor (LCS-MR): the wire ropes are not providing sufficient stretch. Possibly the ropes are overdimensioned, or the number of ropes is excessive.

After Calibration, Line-C shows „L=ERR2“

The sensor deflection is sufficient to satisfy the calibration. The performance of the LCS should now be tested.

6.4 Testing the LCS measurement quality

The quality of results obtained with the LCS will depend largely on the mounting of the sensor, the nature of the structure on which the sensor is mounted, and the behaviour of many other stresses in the complete system: car, rails, ropes etc. It is important now to test the measurement reliability under typical operating conditions. Due to certain mechanical irregularities it might be necessary to use measurement compensation for which the LCS provides various solutions.

Test Empty-Load condition in the floor:

Keeping the lift car in the same floor, check that after one or more persons enter and leave the car, the indicated load („L=xxxx kg“) returns to 0kg, +/- 30 kg. For large lift cars, this tolerance can be expected to be larger.

If the indicated load doesn't return to zero, one or more of the following conditions may apply:

- › **The signal level difference of the sensor is too small.** Although the LCS can be calibrated with a small reference load, best results are usually obtained when using heavier loads. Use the method described above (Checking the Calibration Results) to read the signal values. This problem can only be rectified employing the methods outlined above: After Calibration, Line-C shows „ERR-2“.

- › **The lift car is „sticking“ on the rails.** This effect occurs typically with cantilever lifts, but can occur on non-cantilever systems. Friction between the car-guides and the rails, in connection with the cantilever's offset-load, cause the car to become slightly wedged. The car must be free to slide on the guides such that the minimal movement required for the measurement due to stepping in and out of the car, is transferred through to the ropes. When this is not the case, the stress changes are carried elsewhere and the sensor records unreliable measurements. The cause of this effect could be misaligned rails, insufficient rail lubrication or incorrect guide/rail clearance.

Small signal inconsistencies will always occur, and are mostly negligible. The LCS has an option which will automatically zero out small indicated load offsets up to +/- 30 kg, if there are no detectable loading change for at least 10 sec.

```

/Configuration/Weight-Sensor/LCS Settings/Auto Adjustment/Auto Zero
<30kg = ON

```

Testing the **Empty-Load** condition in all floors

If the Empty-Load condition test is successful, drive the empty car from floor to floor monitoring and recording the indicated load („L = xxxxxkg“) values each time the car is stationary in a floor. Repeat this one or two times to verify that the measurements are consistent in each floor.

There are 3 possible conditions for these repeated empty-load measurements you:

- › **Condition 1:** The measurements in each floor are 0kg +/- 30kg. There is no need for any compensation, the LCS calibration is complete.
- › **Condition 2:** The measurements in each floor are consistent, but some are showing values > +/- 30kg. For this condition it is important to establish that each time the lift returns to a particular floor, the measured load is similar, and doesn't show large fluctuations (which would be condition 3).

This can have various causes:

- Rail misalignment
- Angled rope suspension – especially common in the top floor(s)
- The lift has a compensation chain, and the weight is increasing linearly up the shaft

This condition requires that a measurement compensation be applied individually to each floor. See below, LCS Compensation Options.

- › **Condition 3:** The measurements in each floor are inconsistent, considerably different each time the lift revisits the same floor.

There is no practical compensation method for this condition, the measurements are too unreliable. Although the LCS did not show the „Err-2“ status, it is most likely that the reference weight measurements were too close. It is recommended that you re-calibrate with a higher reference load, or consider re-sitting the sensor as discussed above in After Calibration, Line-C shows „L=ERR 2“.

6.5 Compensation Options

LCS Compensation Options

The LCS offers different methods of automatic measurement compensation. Be sure to have read Testing the Empty-Load condition in all floors before you decide which method you need to apply. It may not be necessary to use any compensation if the ideal sensor mounting position is found.

Compensation Option: Auto-Zeroing

The Auto-Zero function is designed to automatically remove small measurement errors of up to +/- 30kg. This will happen whenever the LCS measures a static offset of under +/- 30kg, for a period of at least 10 seconds. During this time the measured load must not change by more than 10kg. The LCS applies an internal compensation value equal to the inverse value of the currently measured offset.

The Auto-Zeroing compensation value is stored in volatile memory, which means it will be cleared whenever the LCS restarts.

```
/Configuration/Weight-Sensor/LCS Settings/Auto Adjustment/Auto Zero
<30kg = ON
```

Auto-Zeroing may be used in conjunction with Chain-Compensation or Drift-Compensation options.

Compensation Option: Drift-Compensation

The Drift Compensation option is designed to automatically re-calibrate the LCS if the measured load is greater than 30kg for a period of more than 2 hours.

During this time the measured load must not change by more than 10kg. The assumption is that when the lift is not running, the car is left empty. This method, therefore, should not be used if there is a chance that heavy goods will be left in the car for more than 2 hours, which does sometimes occur with freight lifts.

The calibration event can be traced in the FST fault memory by an event labelled „LCS-DRIFT-ADJUSTMENT“. The calibration effectively shifts the LCS operating curve back down to zero, removing any offset, as could be done manually from the FST menu with

```
/Configuration/Weight-Sensor/LCS Settings/Correct Offset.
../Auto Adjustment/Drift Compensation = YES
```

Drift Compensation may be used in conjunction with Auto-Zeroing or Chain Compensation.

Compensation Option: Dynamic – per drive

The Dynamic compensation method works by measuring the difference in loading immediately before and immediately after drive is made. This inverse of this difference is then applied as a dynamic offset for the duration of the stay in the floor. If the lift is using the FST quickstart drive settings, or the pre-opening door timing allows passengers to move in and out of the car before the drive has effectively stopped, the Dynamic compensation method may not be suitable.

The Dynamic compensation value is stored in volatile memory, which means it will be cleared whenever the LCS restarts.

```
../Auto Adjustment/Chain Compensation = Dynamic – per drive
```

A further option is available with the Dynamic compensation method, to always clear the Dynamic compensation value whenever the lift reaches the bottom floor. If the lift does not regularly visit the bottom floor, perhaps because the calls to this floor are locked, the Dynamic compensation method may not be suitable.

```
../LCS Settings/Options = 00000010
```

A '1' set in the indicated bit, will cause the Dynamic compensation value to clear in the bottom floor. Dynamic compensation may be used in conjunction with Auto-Zeroing or Drift Compensation.

Compensation Option: Using Floor Table

The Floor Table option is the best method of tackling load measurement differences on a floor by floor basis, in which the measured loads on each individual floor are similar each time that particular floor is visited (condition 2, above).

An automatic calibration drive is available to generate a table of floor loading-offset values which are then applied automatically whenever the lift car arrives in a floor. The floor table is can be manipulated manually if necessary. This is a quick and ideal method when the lift is fitted with a compensation chain, or when car loading is influenced by rails or ropes in different positions within the shaft.

```
../Auto Adjustment/Chain Compensation = Using Floor Table
```

Once Using Floor Table has been set and saved in the FST menu, the menu will show the following special options:

```
../Auto Adjustment/Floor Values
```

Floor Values presents a list of offset values in kg. for each floor (0..n), which should be the inverse of the actual loading offset measured in the floor. eg. if a floor is normally showing an excess of 94kg with an empty car in floor[2], the Floor Value for floor[2] should be -94kg.

```
../Auto Adjustment/ generate a table
```

Generate Drive is the automatic calibration drive used by the LCS to fill the offset values for the entire shaft. Call Generate Table after the lift has been brought down to the bottom floor. The lift car doors will be locked by the FST, and the car will drive up the shaft stopping at every floor, making an empty load measurement at each stop. After the calibration has completed, the floor table values will applied after the next drive, and thereafter for all drives.

LCS General recommendations for compensation

Providing that the Empty-Reference calibration procedure has generated good working operating characteristics, the LCS will normally deliver excellent and reliable results. The recommendations for normal use are:

```
Auto Zero <30kg = ON
```

```
Drift Compensation = NO
```

```
Chain Compensation = OFF
```

If a floor by floor offset compensation is needed, then the floor table method of Chain compensation is recommended

```
Chain Compensation = Using Floor Table
```

For less than ideal situations, the other compensation methods described above are available.

6.6 Re-calibration after gripping device test

After test of the gripping device or other events it is possible that the characteristic of the load sensor is changed and incorrect values are determined. The resulting offset can have two consequences:

- › The displayed load is higher than the actual load of the car ①
- › The displayed load is lower than the actual load of the car ②

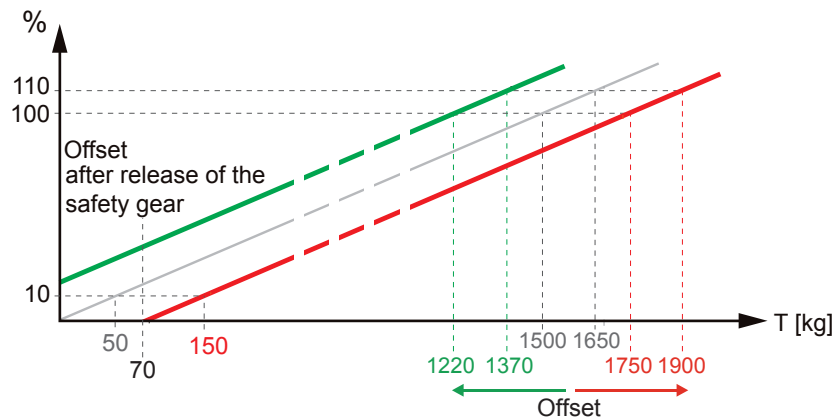

In case of the first offset ①, empty load sensing is not possible anymore while full load and overload are determined significantly too early. The second offset ② can lead to overloading the car before a warning is issued.

Therefore, you should always re-calibrate with an empty car after a gripping device test. If the lift system is parked for a longer period of time and the difference is < 30 kg, the offset is corrected automatically by the LCS. Offsets > 30 kg are not corrected automatically and must be corrected manually. Please use menu item `Correct-Offset` for this purpose (the car is empty). This function determines the current offset of the characteristic curve and corrects it so that the measuring accuracy from before the gripping device test is restored.



Do not use the empty car calibration function for this correction as this will change the rise of the load characteristic and measuring results will no longer be correct.

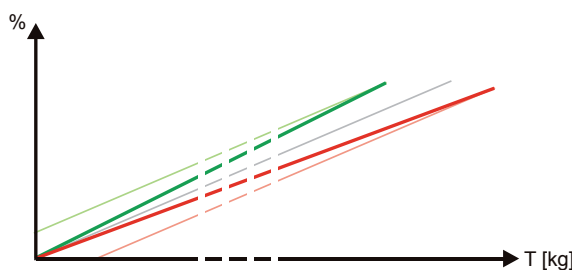

Wrong offset correction by the empty car re-calibration.

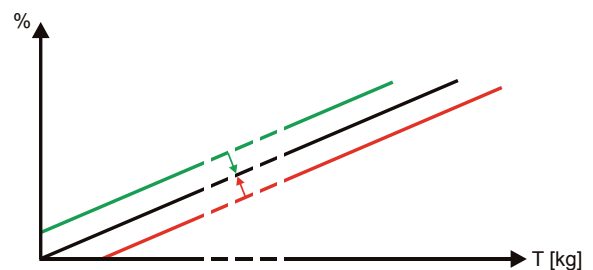

Correct offset correction through the menu function `Correct Offset` of the FST-2.













7 FST parameter settings

You can find all parameters for parametrising the LCS and calibrating the loads in the menu under `Config \Weight Sensor`. The following parameters are available:

Menu item	Description	Setting range
Sensor type	Set LCS, exit menu and save settings. Then, the following menu items are visible. Type of connected load measuring device.	Analogue sensor Digital sensor LCS
LCS-settings Threshold-Empty	Load limit for an empty car. As long as this limit is not exceeded, the FST displays an empty load. Standard = 40 kg.	0 ... 1000 kg
LCS-settings Threshold-Full	Settings of threshold, the limit value from which the car is considered to be full.	0 ... 30000 kg
LCS-settings Lift. max-Capacity	Permitted load (nominal load Q) of the lift system.	0 ... 30000 kg
LCS-settings Reference weight [L2]	Reference load used during calibration of the LCS. The reference load can be significantly smaller than the permitted load, but with a larger load measurements are more exact. Enter the reference load as exact as possible.	0 ... 30000 kg
LCS-settings Cal.-empty [L1]	Perform calibration of the empty car. <i>See chapter „6.1 Calibration guide using the FST keypad“ on page 13</i>	YES NO
LCS-settings Cal.Ref. [L2]	Perform calibration of the car with set reference load. <i>See chapter „6.1 Calibration guide using the FST keypad“ on page 13</i>	YES NO
LCS-settings Correct Offset	Perform post-calibration of the empty car if the load measuring after the gripping device test or other events has changed. <i>See chapter „6.6 Re-calibration after gripping device test“ on page 19</i>	YES NO
LCS-settings Cal.(L1/L2) from COP	Perform calibration of the empty car and with the set reference load from the COP car operating panel using FPM. <i>See chapter „6.2 Calibration guide using the car panel“ on page 14.</i>	YES NO
LCS-settings Auto Adjustment Chain Compensation	<ul style="list-style-type: none"> › OFF: Turn off compensation of measuring tolerances due to mechanical irregularities. › Using the Floor Table: Adjust the car's calibrated empty load for each floor. This function allows to compare the differences of the calibrated empty load and the actual empty load for each floor and sets the weight accordingly to „0“ kg. › Dynamic per drive: Use the car's weight after the doors have been closed as the actual weight when the target floor has been approached (it does not depend on weight irregularities due to other influences such as travelling cable, balance ropes, rail mounting etc). 	OFF using Floor Table Dynamic

Menu item	Description	Setting range
LCS-settings Auto Adjustments Floor Table	is displayed only if Compensation chain = has been saved Using Floor Table. All the correction data are included in the table (the determined difference between the calibrated empty car and relevant floor). The correction data is recorded with „Tabelle erfassen“. A manual individual adjustment of the difference value can be achieved by pressing S + UP / DOWN	kg value / floor
LCS-settings Auto Adjustments Generate a table	Automatic collection of the deviation of the empty load in each floor. After you have confirmed, a message LCS Generate a table generate a table“ appears. If the doors and calls are locked, the fully automatic measuring drive follows, starting from the bottom floor to each floor.	YES NO
LCS-settings Auto Adjustments Drift compensation	After the car comes to a standstill (120 min.) and after unchanged measuring the measured weight will be set to „0“. Operating safety is invalid here! Use only in passenger lifts, where the load will be placed on the car for no longer than 2 hours.	YES NO
LCS-settings Auto-Adjustments Auto-Zero: <30kg	If the lift is stationary with closed doors for more than 10 s, a loading weight is smaller than (< 30 kg), it will be automatically corrected to „0“.	ON OFF
LCS-settings Auto-Adjustments LCS-Reset	Restart of LCS module Parameter values are saved	YES NO
LCS settings Options	> 00000001: Display measurement during drive > 00000010: If LCS settings are Auto-Adjustment / Dynamic an Offset will be deleted automatically in floor 0. > 00001000: The empty load input on the FSM-2 can be used simultaneously with this setting	00000001 00000010 00001000

8 Error messages and diagnostics

Error or error image	Reason	Action
ERR 1 (Line C with  or )	Sensor failure Fault A/D-Wandler (internal fault).	› Replace LCS modul
ERR 2 (Line C with  or )	Calibration error The load difference between L1 and L2 is too small.	› Repeat measure reference load › Increase reference load, repeat measure › Bending is not enough, set the sensor in a suitable place, repeat measure
ERR 3 (Line C with  or )	ADC Fault - Hardware	› Replace LCS modul
ERR 4 / LCS DATA MISSING (Line C with  or )	Connection error no data is received from LCS	› Examination of the bus connection › Examination of the jumper settings
ERR 15 (Line C with  or )	Other errors	› Contact the NEW <i>LIFT</i> service line
Switch between different kg values L= xxxx kg	FST gets signals from multiple LCS modules with the same jumper settings. The wrong jumper settings of the group-specific LCS.	› Examination and correction of the jumper settings › Press  or  until L= xxxxx kg appears
LCS DATA Missing	LCS module is not connected to LON BUS, the jumper settings for group assignment is wrong; the device is faulty.	BUS cable, as well as terminator (terminating resistor), check connection, if necessary LON BUS Start Search. Check jumpers, see Chapter 3. Replace the device.

NOTES

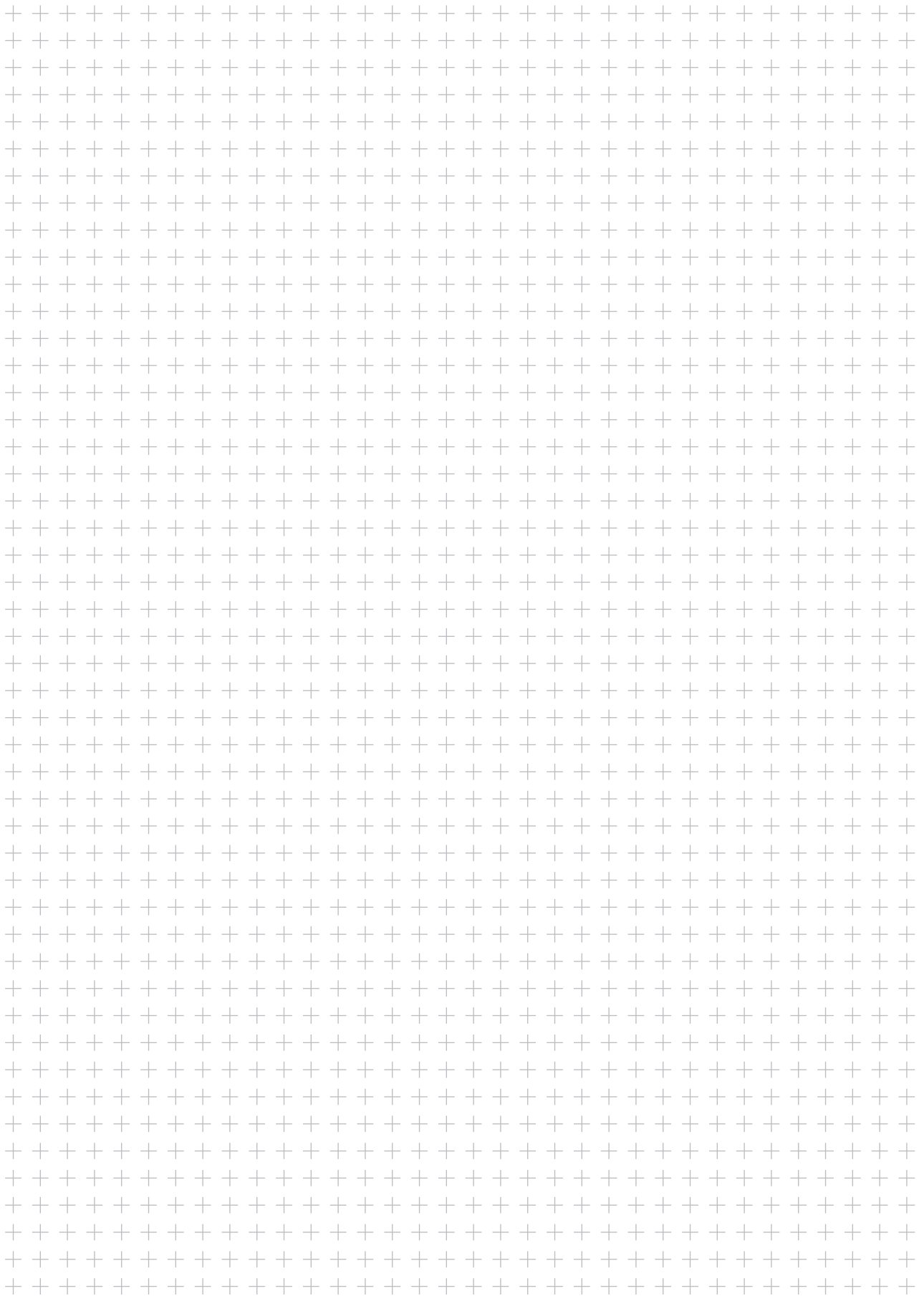

📍 **NEW LIFT** Neue Elektronische Wege
Steuerungsbau GmbH
Lochhamer Schlag 8
DE 82166 Gräfelfing

☎ +49 (0) 89 898 66 0
📠 +49 (0) 89 898 66 300
✉ info@newlift.de
🌐 www.newlift.de

📍 **NEW LIFT**
Service Center GmbH
Ruwerstraße 16
DE 54427 Kell am See

☎ +49 (0) 6589 919 540
📠 +49 (0) 6589 919 540 300
✉ info@newlift-sc.de
🌐 www.newlift.de